

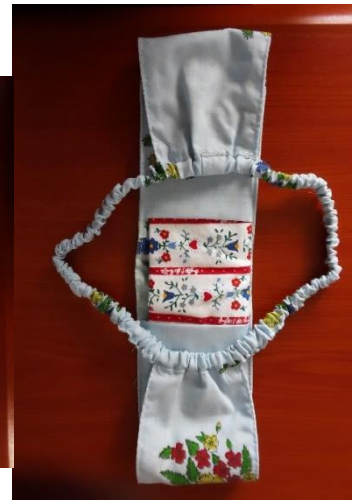

**USAID**  
FROM THE AMERICAN PEOPLE



# Guidelines for making face masks and reusable hygiene pads



Developed for RANO WASH by RAMAPIAVA Rasoamampionona Sylvia  
May 2020



## **DISCLAIMER**

This guideline is made possible by the generous support of the American people through the United States Agency for International Development (USAID) under the terms of the Cooperative Agreement AID-687-A-17-00002 (RANO WASH), managed by Cooperative for Assistance and Relief Everywhere Inc (CARE). The contents of this report are the sole responsibility of the RANO WASH consortium and do not necessarily reflect the views of USAID or the United States Government.

# MAKING REUSABLE FACE MASKS

## I- Required materials

- Fabric (outer side) : (20 cm x 15 cm) x 2
- Lining (inner side) : (20 cm x 15 cm) x 2
- Elastics : (2 x 15 cm)

Our mask is made of cotton, and the lining is made of tergal. (“two” masks are made)

1 meter of fabric with “1 m 50” width can make 25 masks.

## 2- Pattern

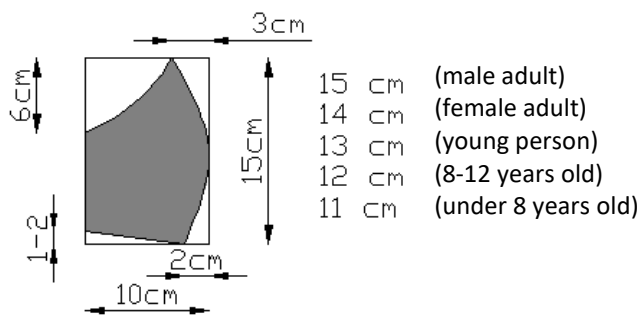

## 3- Pattern laying on fabric

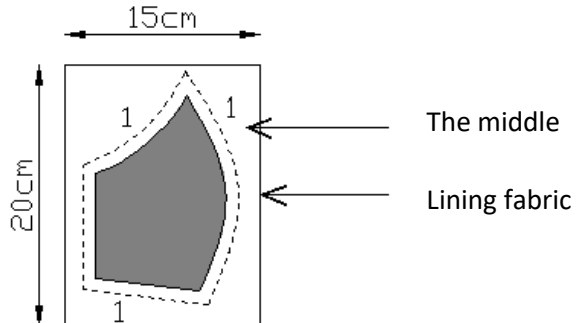

- Leave 1 cm (sewing) all around the pattern
- A similar cut of visillin is made and sewed on the reverse side
- Cut the inner side fleece similarly

## 4- Sewing

- First, sew together the middle of the outer side (coton cloth)
- Do the same for the inner side(fleece)

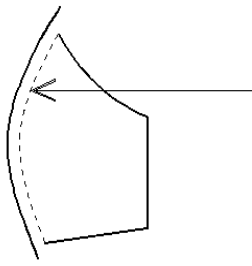

The outer side of the fabric is sewed into the middle

- Do the same for the inner side of the fabric
- **Then you can get the following:**

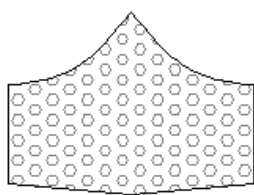

Inner side

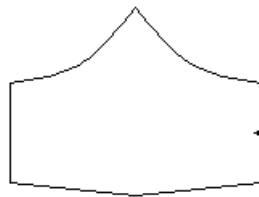

Outer

- The inner and outer sides are sewed together

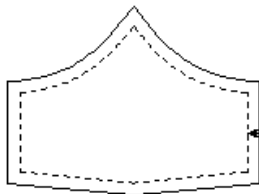

Sewing

- The top and bottom are sewn first, the edges are left aside
- A "15 cm elastic" is inserted on the inside edge

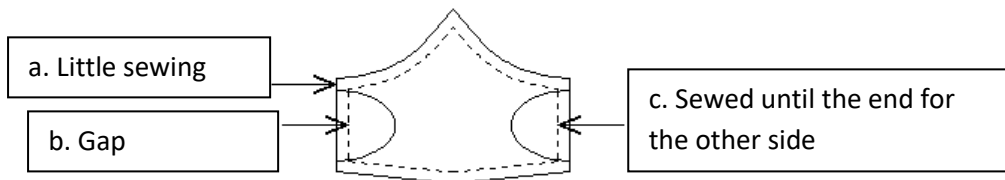

- (a): Sew a little
- (b): Leave a gap to turn it over to its right side
- (c): The other end is sewed until the end
- They are then turned over to the right side
- The face mask is then sewed all over the edges. Make 1 mm sewing along the edges.
- Then iron the all

## MAKING HYGIENE PADS USED WITH UNDERWEARS

### 1- Required materials

- “Cotton fabric”: 2 types:
  - Outer side: Simple Cotton (Example sheet cloth)
  - Inner side: Finety
- Plastic cloth (“waterproof fabric”)
- “Plastic press” or “lock”
- Needles
- Threads

### 2- Dimensions

- For adults :
  - Pocket : (25 cm x 27 cm)
  - Finished hygiene pad : (22 cm x 30 cm)
  - Plastic cloth : (11 cm x 27 cm)
- For young people :
  - Pocket : (22 cm x 25 cm)
  - Finished hygiene pad : (19 cm x 21 cm)
  - Plastic cloth: (10 cm x 25 cm)

NB : 1 meter fabric with 2m 40” width can make 12 pockets

### 3- Pattern (Pocket)

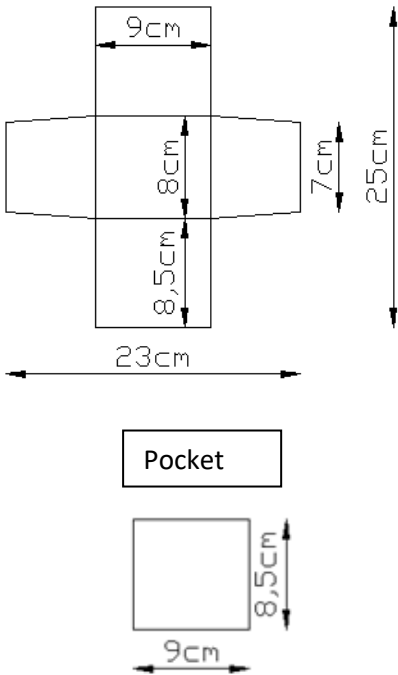
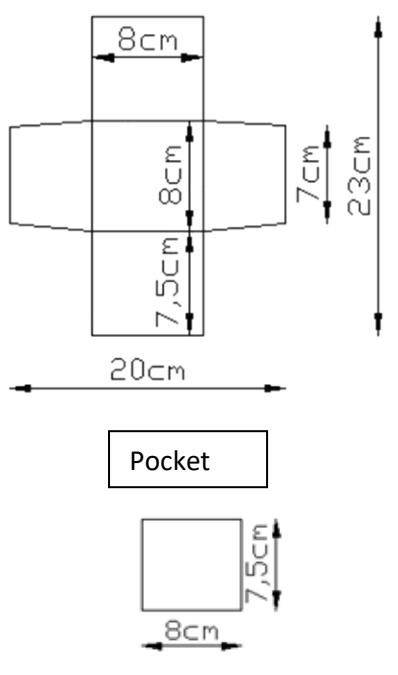
Adults	Young people
 <p>The pattern for adults consists of a main body and a pocket. The main body is a cross-shaped net with a central rectangle of 23cm width and 25cm height. The top flap is 9cm wide and 8cm high. The bottom flap is 8.5cm wide and 8cm high. The side flaps are 7cm high. The pocket is a rectangle measuring 9cm by 8.5cm.</p>	 <p>The pattern for young people consists of a main body and a pocket. The main body is a cross-shaped net with a central rectangle of 20cm width and 23cm height. The top flap is 8cm wide and 8cm high. The bottom flap is 7.5cm wide and 8cm high. The side flaps are 7cm high. The pocket is a rectangle measuring 8cm by 7.5cm.</p>

### 4- Pattern laying on fabric

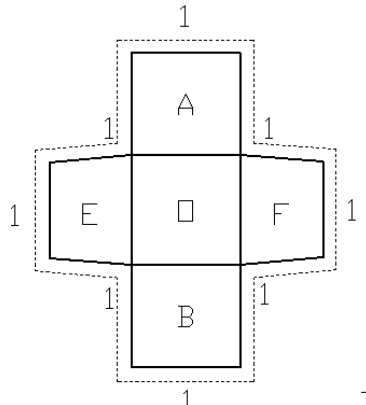
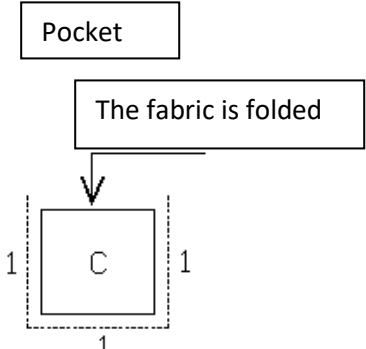
 <p>Diagram showing the pattern pieces A, B, C, E, and F laid out on a fabric. Each piece is surrounded by a 1cm dashed line indicating the sewing allowance.</p>	<ul style="list-style-type: none"> <li>- Cut the fleece cloth (the inner against the outer side )</li> <li>- Do 1 cm sewing around the edges</li> <li>- Then cut the cloth</li> </ul>
 <p>Diagram showing the pocket piece C on a folded fabric. The fabric is folded in half, and the pocket piece C is placed on top. A 1cm dashed line indicates the sewing allowance.</p>	<ul style="list-style-type: none"> <li>- Make 1 cm sewing on the 3 sides except for the top of the fabric</li> <li>- Cut 2 times</li> <li>- Do the same for that meant for the young people but different in size</li> </ul>

## 5- How to sew it

- It is recommended that the plastic cloth has the following dimensions:

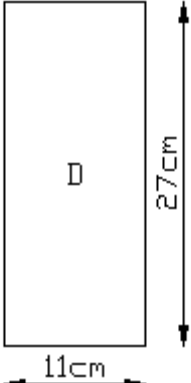
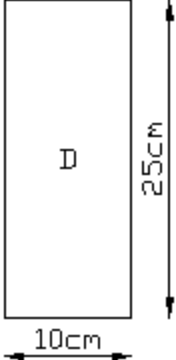
<b>Adults</b>	<b>Young people</b>
	

- C is inserted between A and B so that the fold in C is centered.
- Slowly place D on top
- Sew these together to leave gap on E to be turned on later
- Then iron it

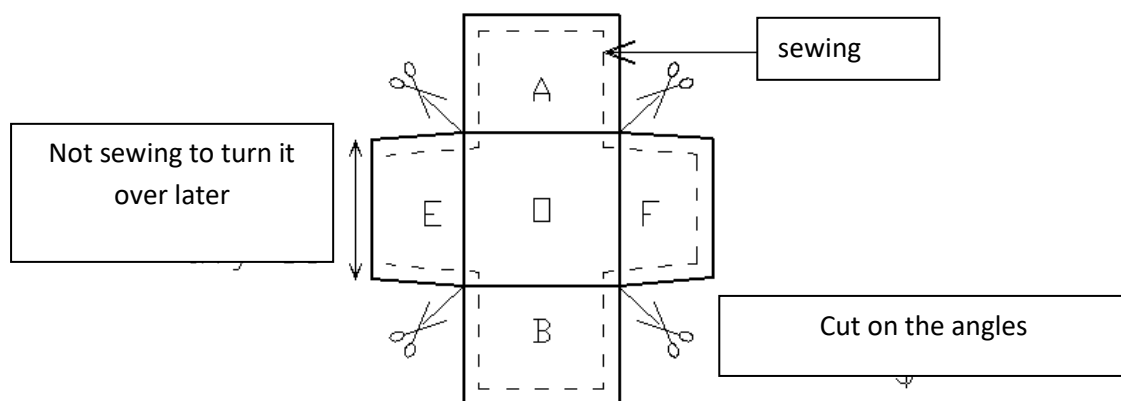

- It is then turned over
- Sew 1 mm around the edges.

## 6- Pattern : (underwear)

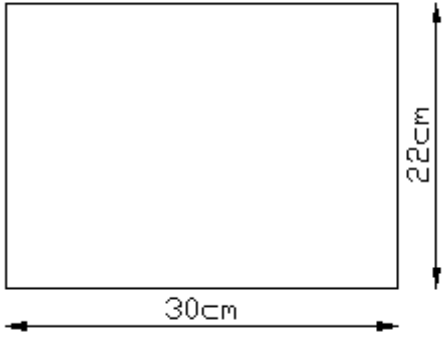
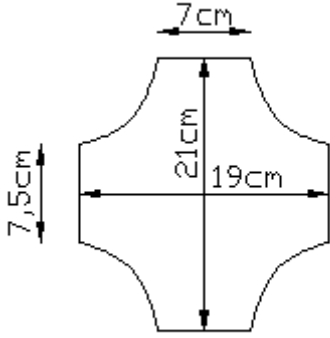
<b>Adults</b>	<b>Young peoples</b>
 <p>A rectangular pattern for adults underwear. The width is labeled as 30cm and the height is labeled as 22cm.</p>	 <p>A cross-shaped pattern for young people's underwear. The top horizontal width is 7cm. The central vertical width is 21cm and the central horizontal width is 19cm. The bottom vertical width is 7,5cm.</p>

## 7- Installing a "pattern" on a cloth

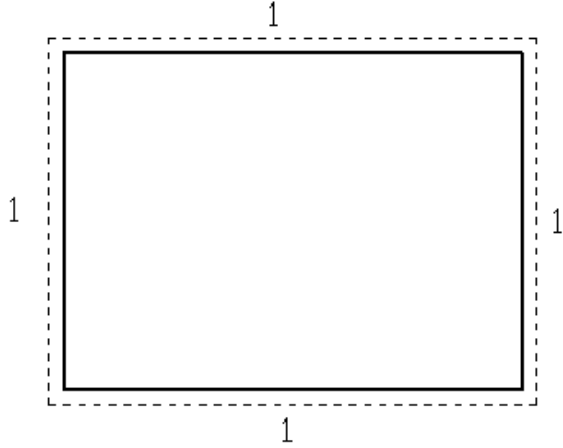
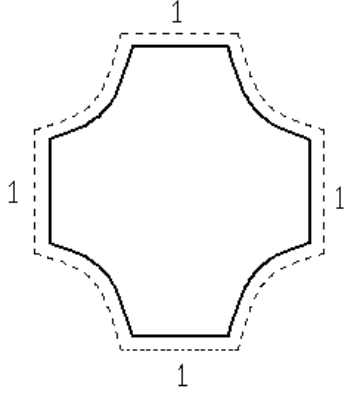
<b>Adults</b>	<b>Young people</b>
 <p>A rectangular pattern on a cloth. The pattern is a solid rectangle with a dashed border around it. The number '1' is placed at the top, bottom, left, and right sides of the dashed border, indicating a 1cm margin.</p>	 <p>A cross-shaped pattern on a cloth. The pattern is a solid cross with a dashed border around it. The number '1' is placed at the top, bottom, left, and right sides of the dashed border, indicating a 1cm margin.</p>



## 8- How to sew it

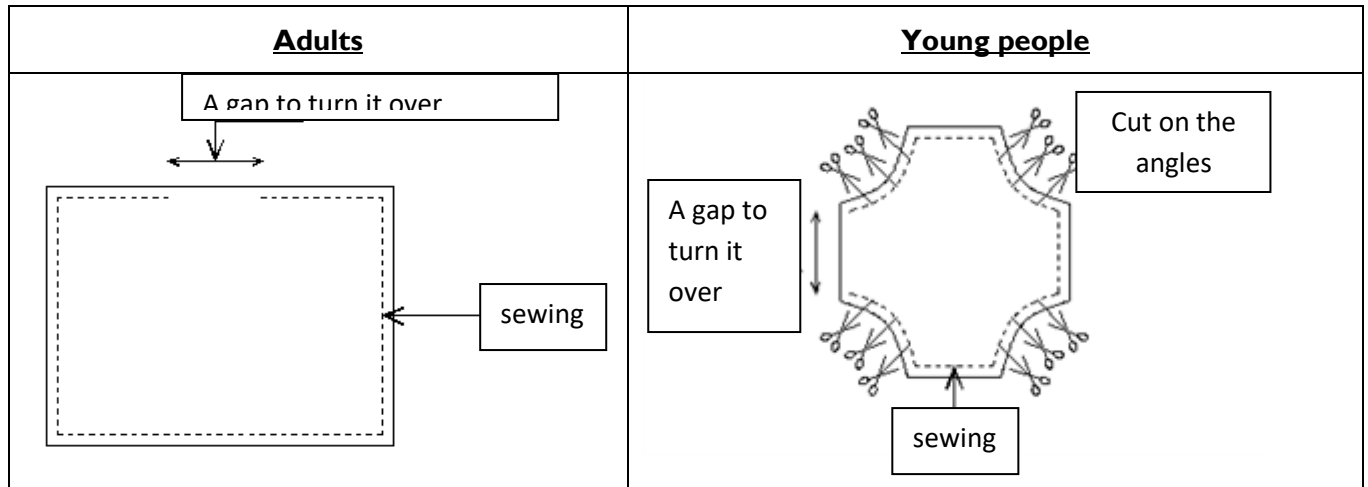

- Sew the surroundings to leave a small gap to turn it over
- Then reverse it
- Sew around the outside edge and make it 0.5 cm thick
- Iron it all once finished

## MAKING HYGIENE PADS USED WITHOUT UNDERWEARS

### I- Required materials

- Cotton cloth : (52 cm x 11 cm) (fleece)
- Plastic cloth : (25 cm x 11 cm)
- Elastic : 60 cm
- Hygiene pag : (30cm x 22 cm) vita
- Belt to put the elastics on: (5 cm x 1,20 m)

## 2- Pattern (Pocket)

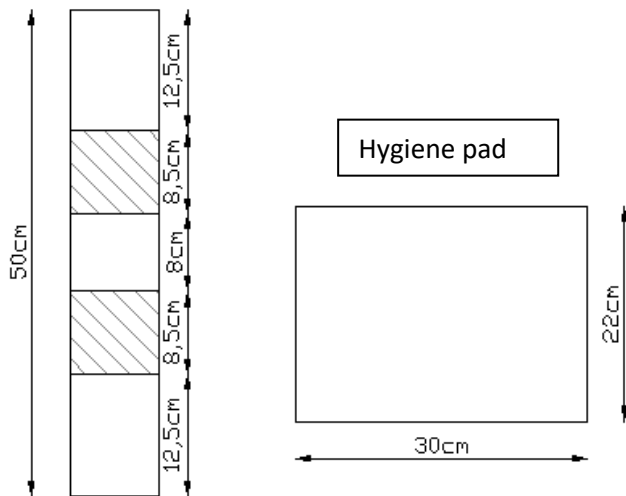

## 3- Installation of the pattern on the fabric

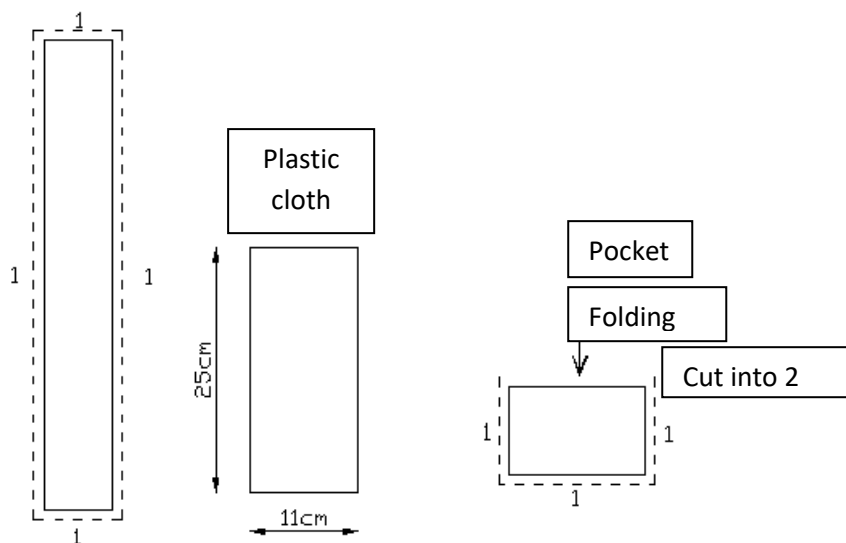

## 4- How to sew it

Sew the circumference so that the pocket is inserted between the cloth which is 13.5 cm apart from each of the two ends. The foldings on the pockets should be put side by side on the plastic cloth.

- Leave one of the ends to turn it over
- Then turn it over
- Sew the edges of 1 mm
- Then sew the edges of the pocket

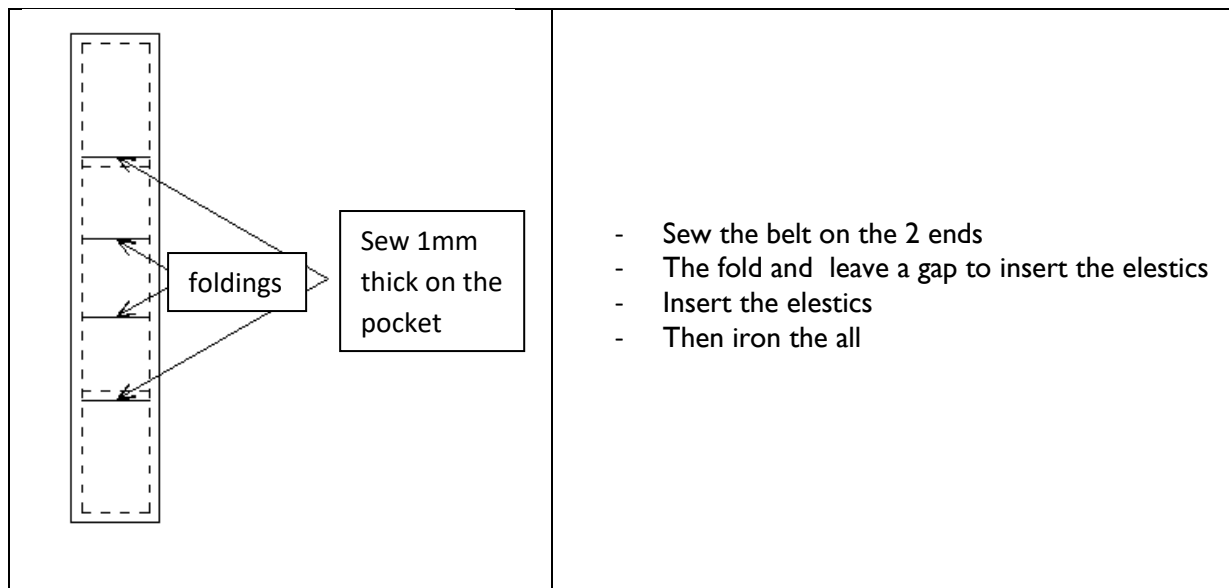

## 5- Hygiene pad

- It is made the same way as how it is made for an adult